

# Indus-2 Beam Diagnostic Systems - Commissioning Experience

Tushar A. Puntambekar  
Beam Diagnostics Section  
RRCAT, Indore

# Main Parameters of Indus-2

Energy		: 2.5 GeV
Current		: 300 mA
Critical Wavelength ( $\lambda_c$ )		: 1.986Å
Circumference		: 172.47 M
Beam emittance	X	: $5.81 \times 10^{-8}$ m.rad
	Y	: $5.81 \times 10^{-9}$ m.rad
Revolution frequency		: 1.738 MHz
RF frequency		: 505.812 MHz
Harmonic Number		: 291

# Transfer Line-3 and Indus-2 diagnostic systems layout

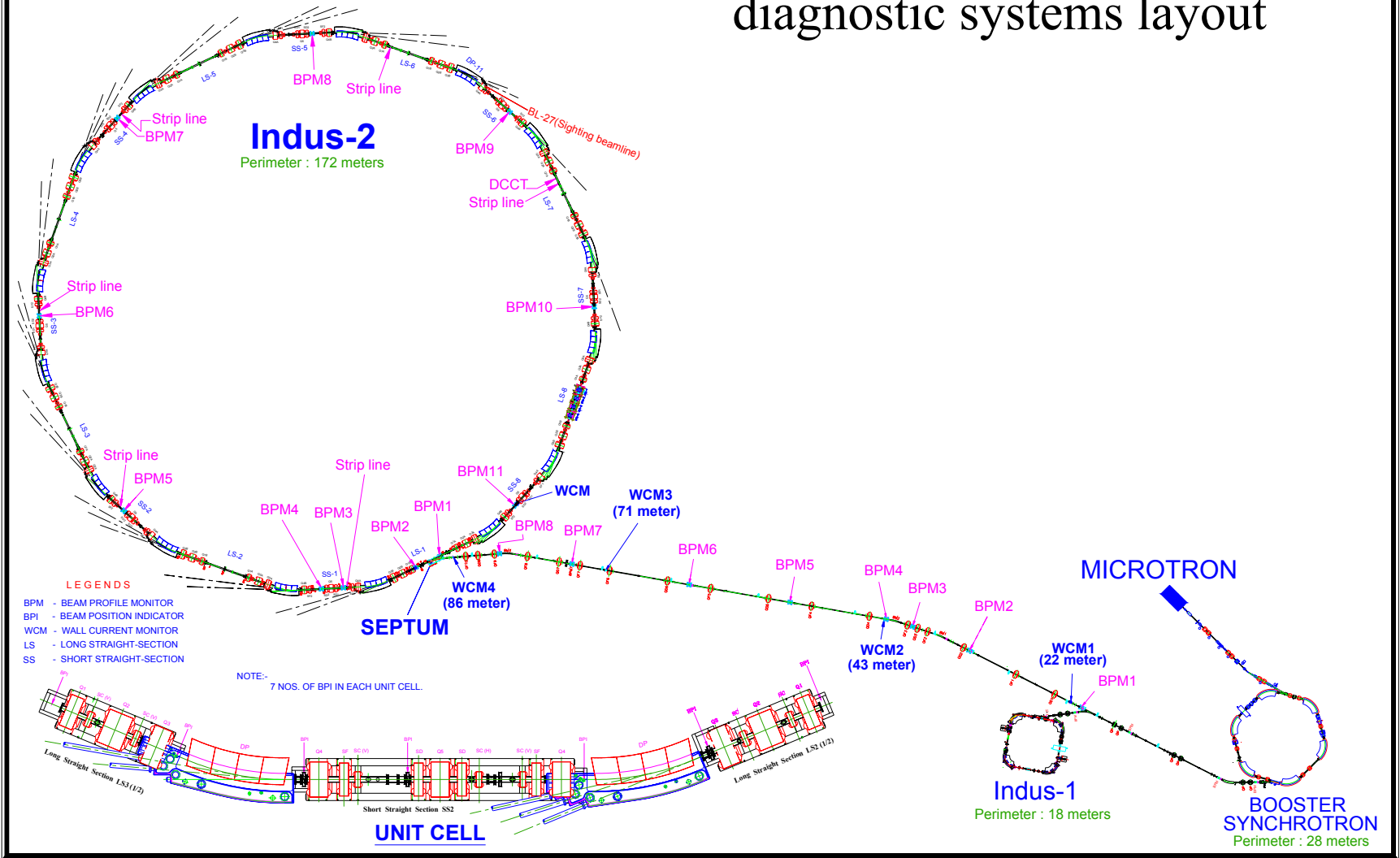

# Beam diagnostic devices in TL-3 and Indus-2

S. No.	Name of diagnostic device	Total number	Function
1	Beam Profile Monitor	19	Visual observation of beam profile and position
2	Wall Current Monitor	5	Observation of instantaneous bunch signal
3	DC Current transformer	1	Measurement of average beam current
4	Beam Position Indicator (Beam Position Monitor)	56	Measurement of beam position, closed orbit distortion
5	Stripline	6	Tune measurement and Beam signal observation
6	Sighting Beam Line	1	Observation of synchrotron light during machine commissioning
7	Horizontal and vertical Scraper	3	Measurement of beam intensity profile along horizontal & vertical axes
8	Thick and thin Septum Hole Monitors	2	Visual observation of the injected beam at the septum mouth.

# Beam Profile Monitor (BPM)

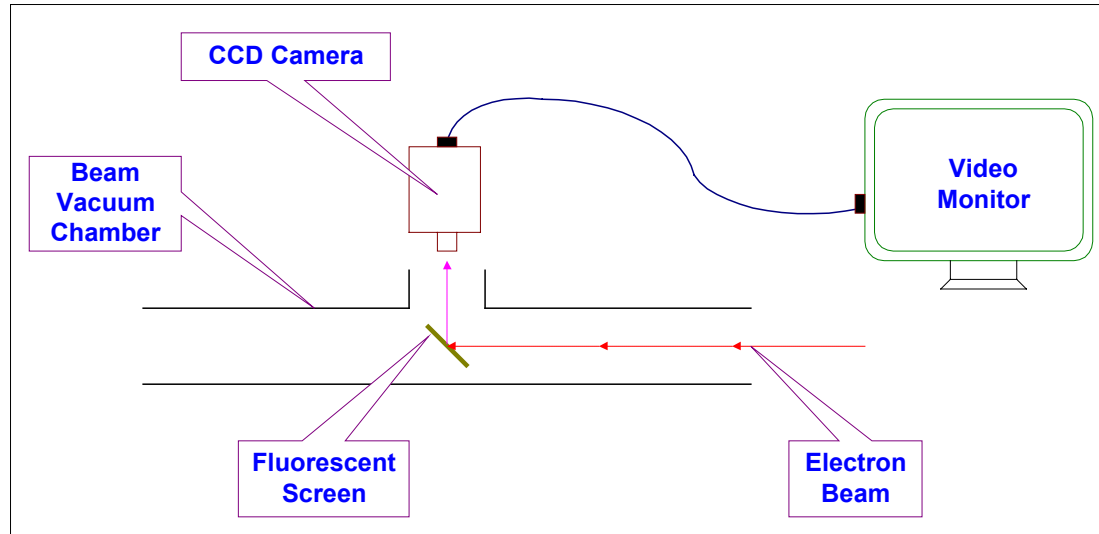

- Cr doped  $\text{Al}_2\text{O}_3$  fluorescent screen
- visual observation of transverse shape, orientation and position of the beam
- Interceptive device
- Used mainly during commissioning and startup of accelerator

# BPM Mechanical Structure

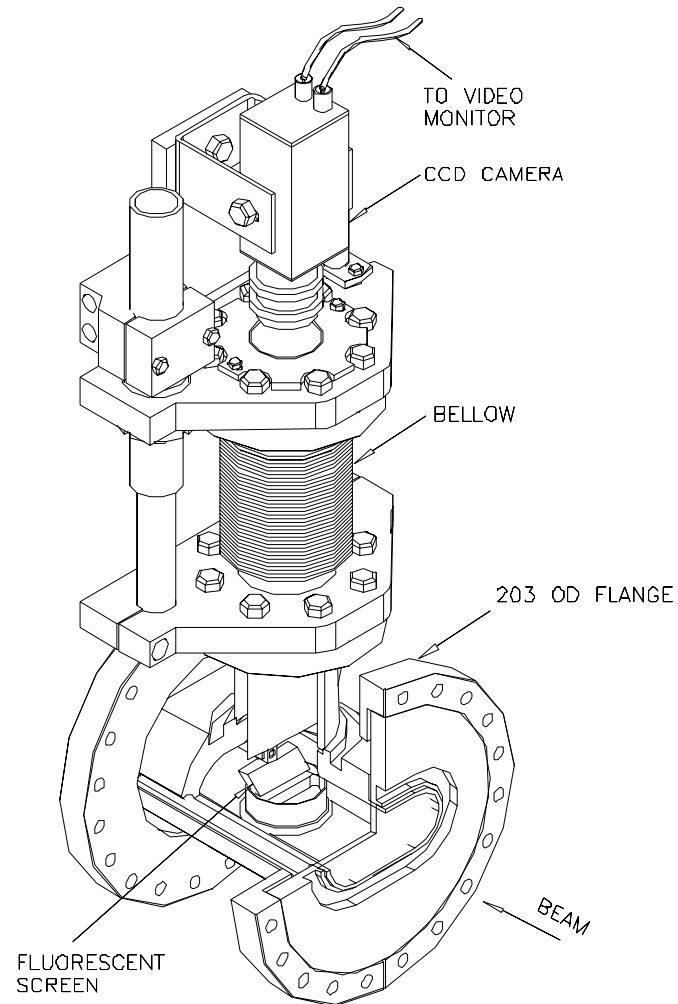

# Photograph of BPM & Fluorescent Screen



15-Jan-08

JAS 08, RRCAT, Indore

7

# BPM in TL-3 and Indus-2 Ring

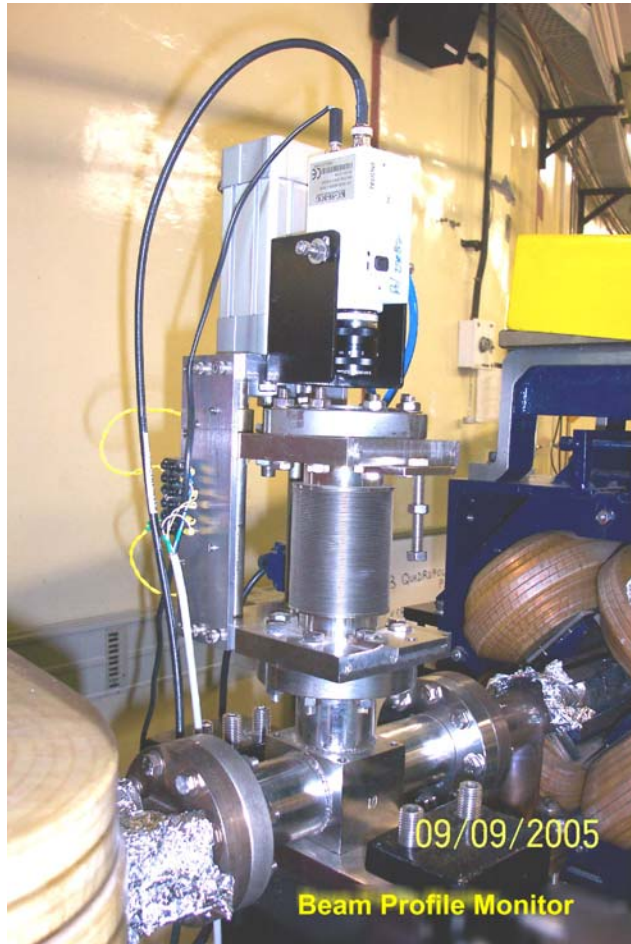



# System Block Diagram

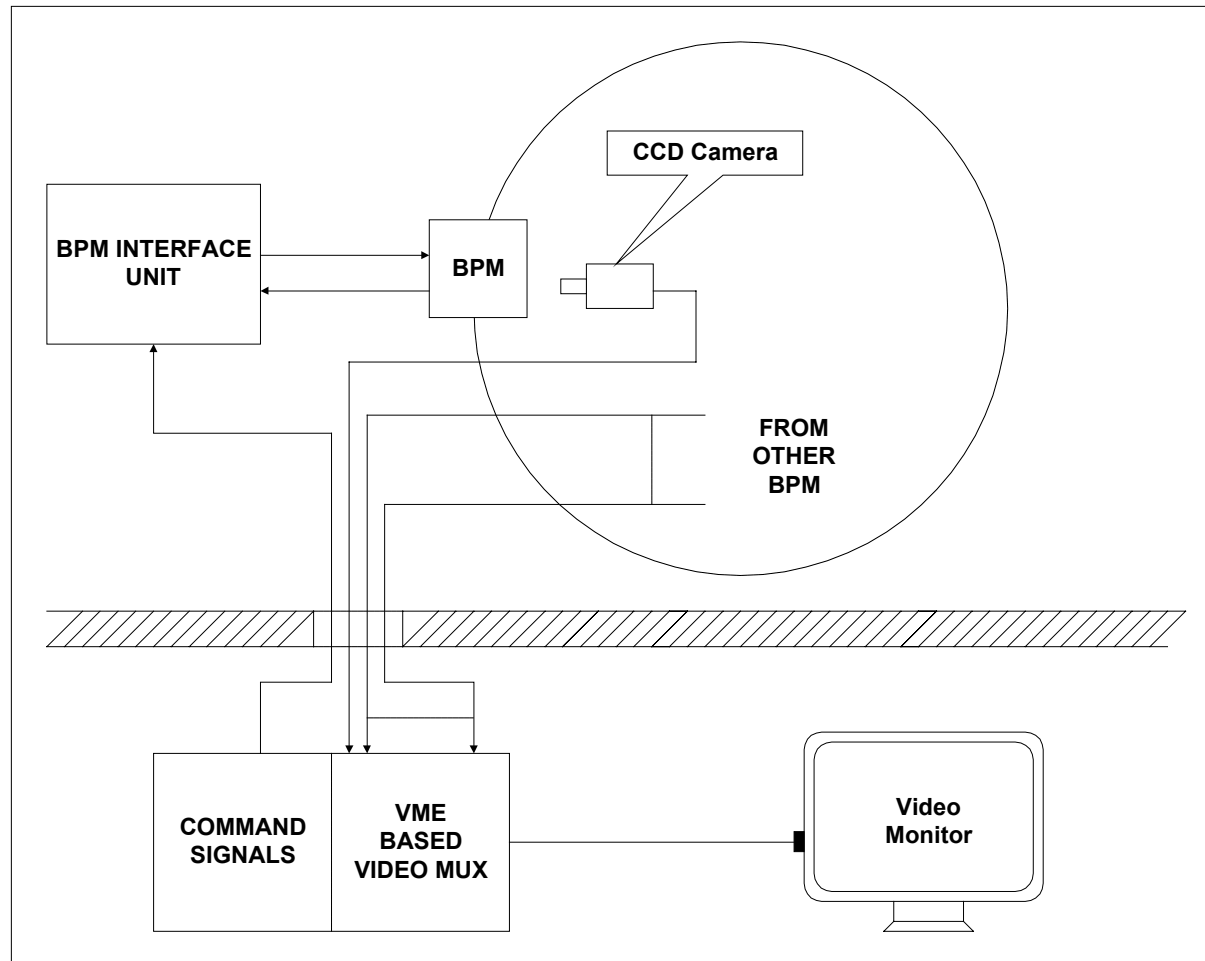

# VME Based Video Multiplexer- Photograph

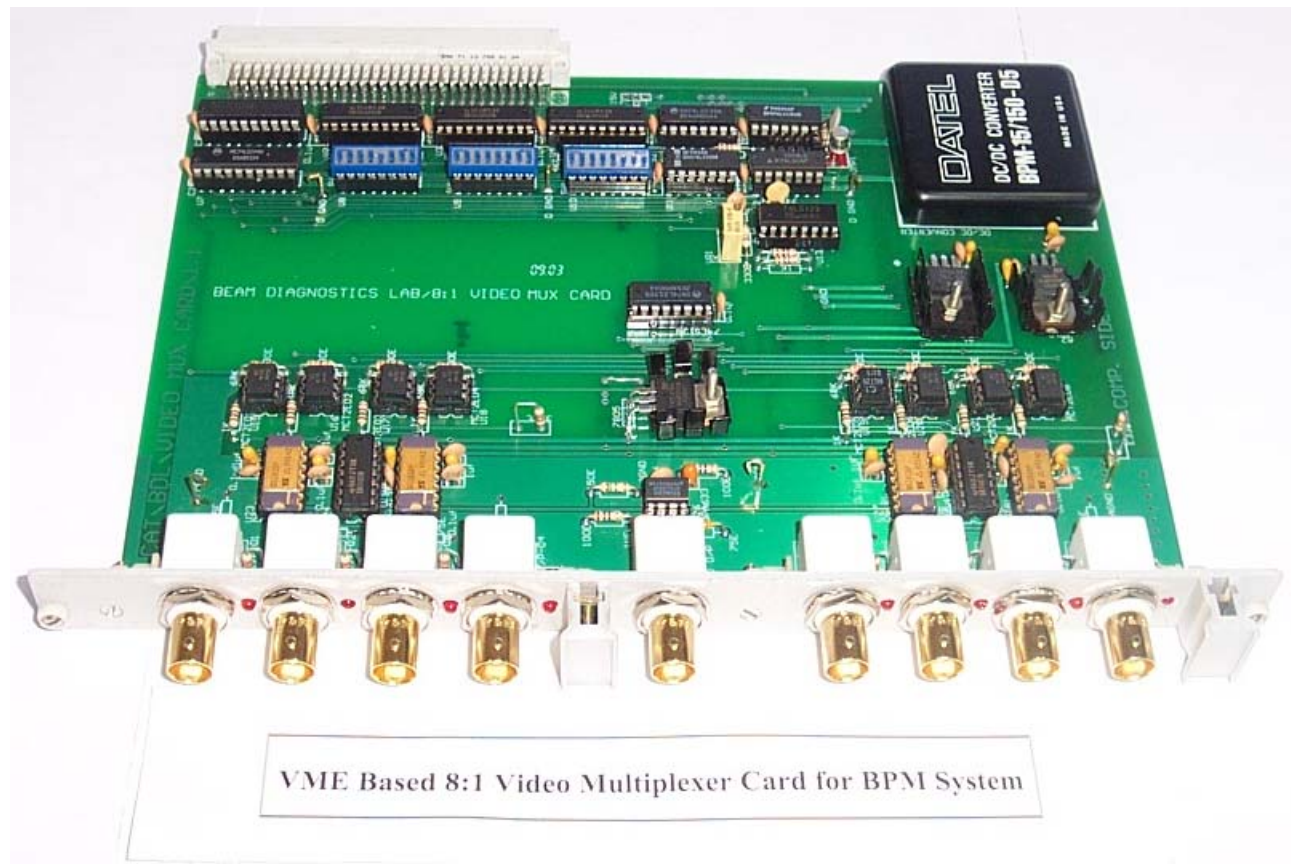

# Beam spots observed during commissioning

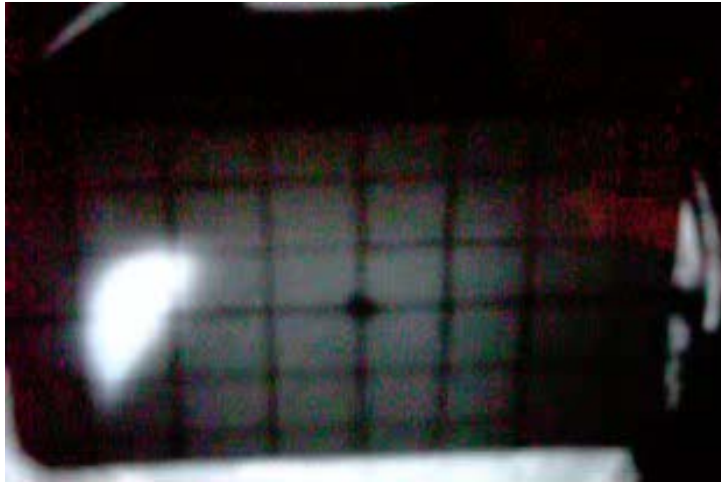

# Wall Current Monitor (WCM)

- Non-interceptive device to observe pulsed beam current (electron bunches)
- Beam current flowing in the vacuum chamber is accompanied by an equal and opposite “wall current”(Image current) flowing on the inner surface of the vacuum chamber
- Used for optimization of beam transfer through TL-3 and observation of circulating bunches (turns) in Indus-2 storage ring

# Wall current monitor schematic

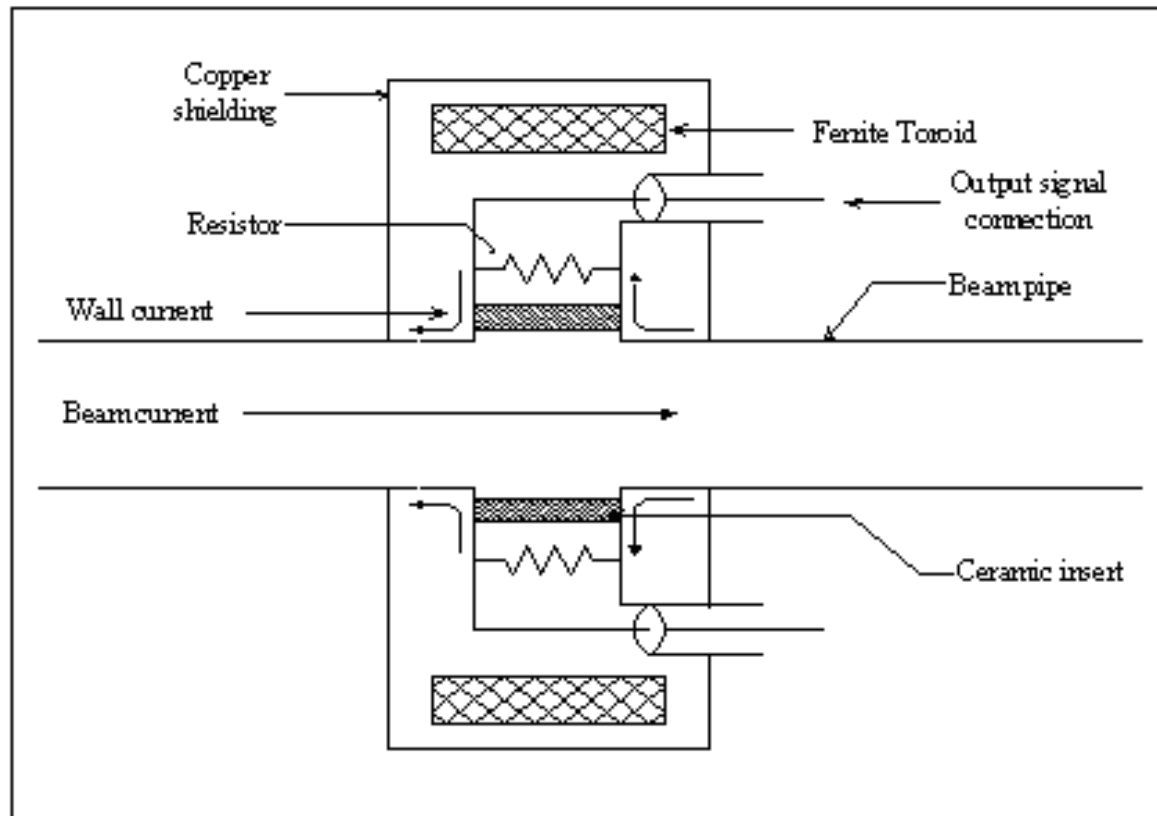

# Wall current monitor waveforms

WCM 1  
WCM 2  
WCM 3  
WCM 4

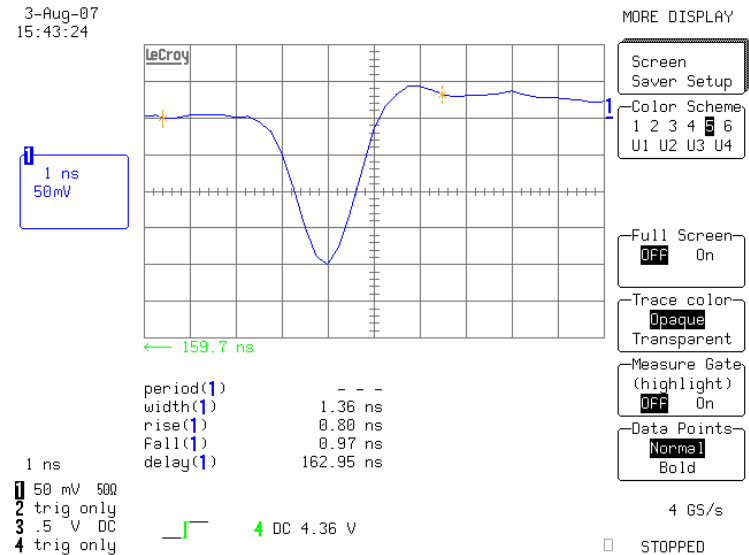
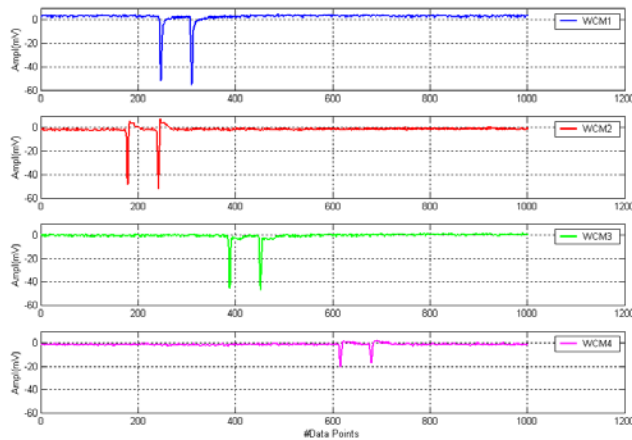
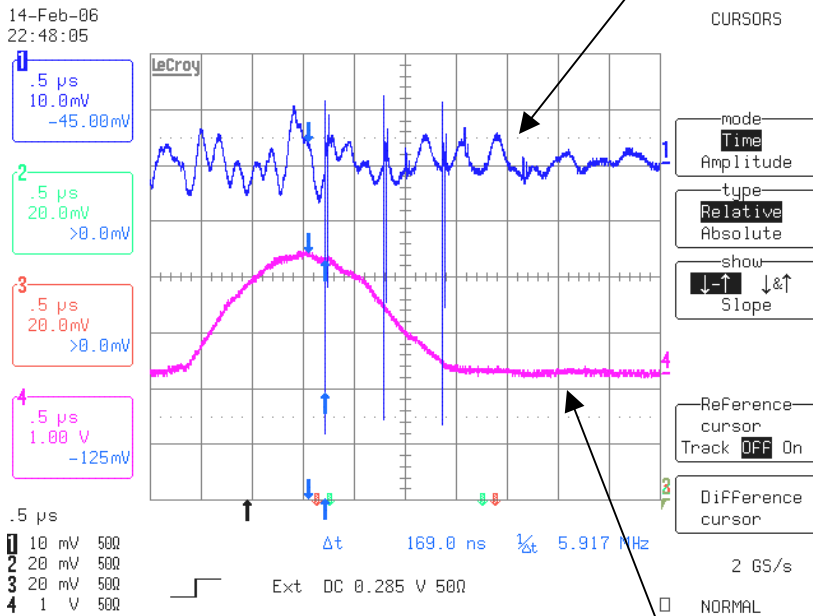

**Fig.** Beam transport through TL-3 as seen on WCMs.

**Fig.** Bunch signal in TL-3

# Beam circulation in Indus-2

## Indus-2 WCM signal



## Injection kicker

Beam circulation for three turns

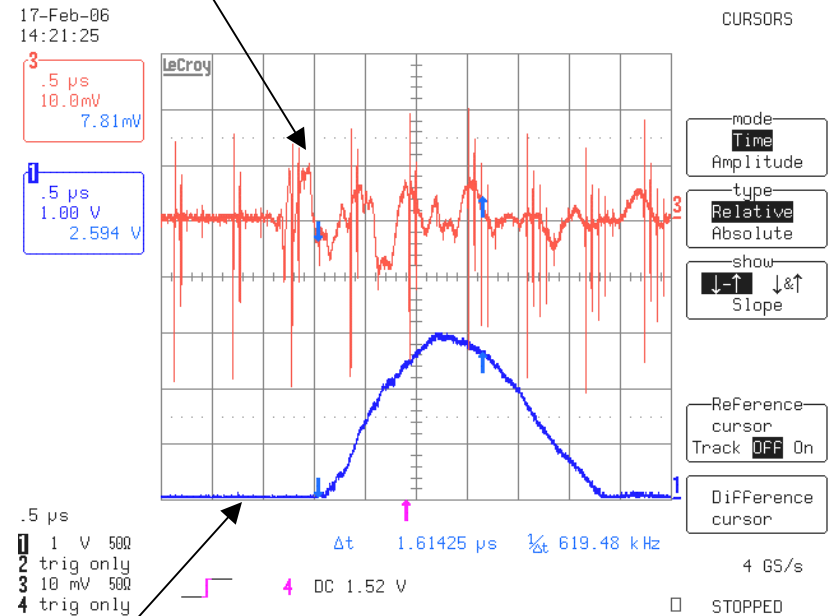

Beam circulation for > 1 sec.

# Indus-2 WCM waveforms ...

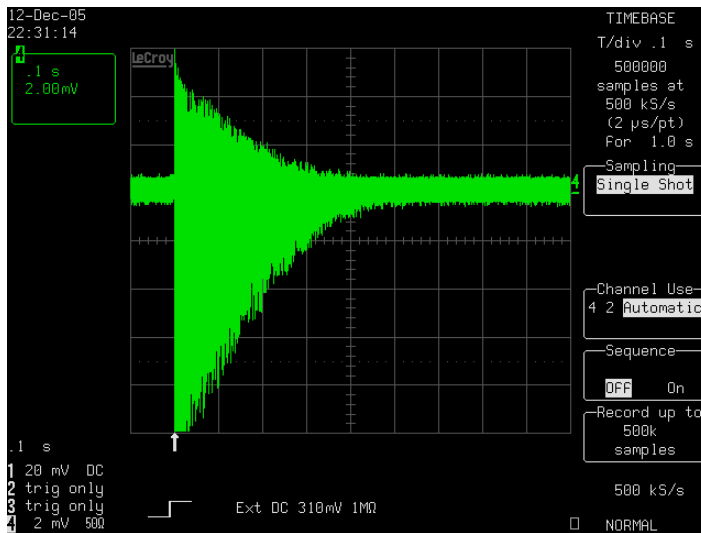

400 msec. beam  
circulation (12/12/2005)

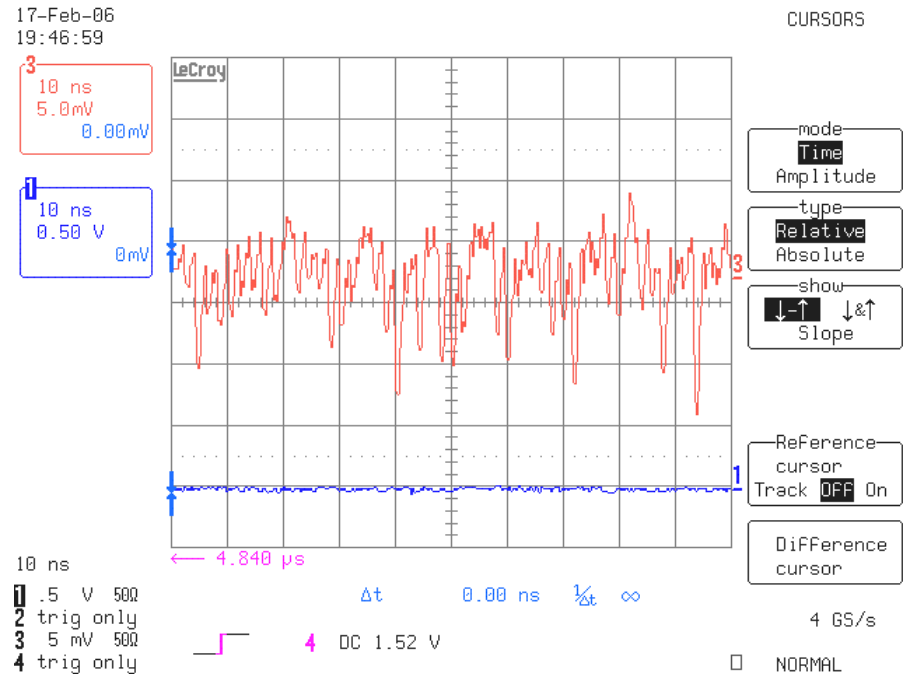

Indus-2 bunch signal



# SR Sighting Beam Line

- Sighting Beam Line (SBL) is a Synchrotron radiation based diagnostic beamline to monitor the beam parameters specially during commissioning of the Indus-2 machine, when beam current is low and other monitors in the ring are not much effective. Machine operators can visually observe the synchrotron radiation. SBL has a front end consisting of slit, radiation absorber, all metal pneumatic valve, and fast shutter. It has Mirror box fitted with CCD camera to measure the beam size, position along with visual observation.

# Photograph of sighting beam line and synchrotron light (inset)

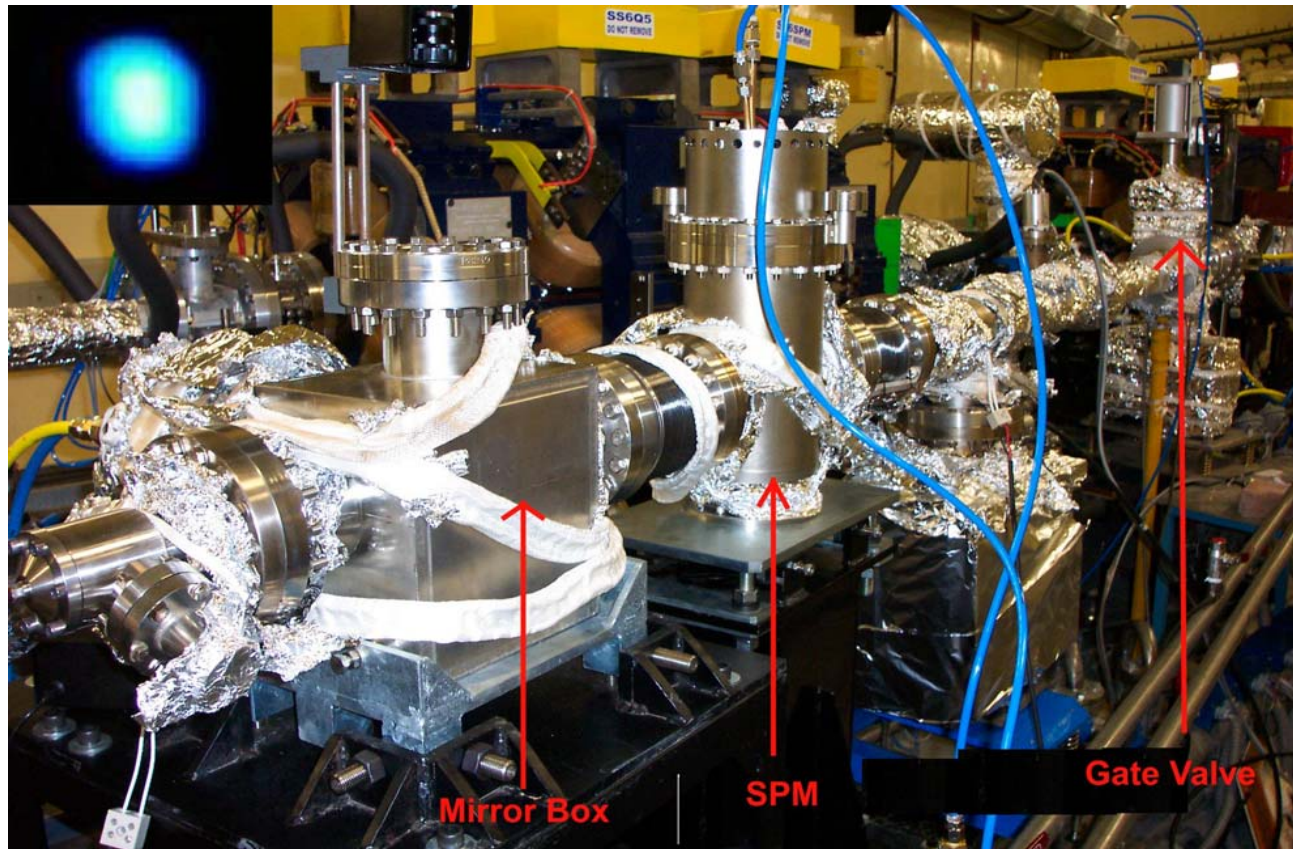

# DC Current Transformer

- Used for the measurement of the stored average current in the storage ring
- An insulating gap in the chamber is needed to stop the wall current flowing through the core
- Thermal and magnetic shielding are required
- High frequency bypass across the gap

# Schematic of DCCT Assembly

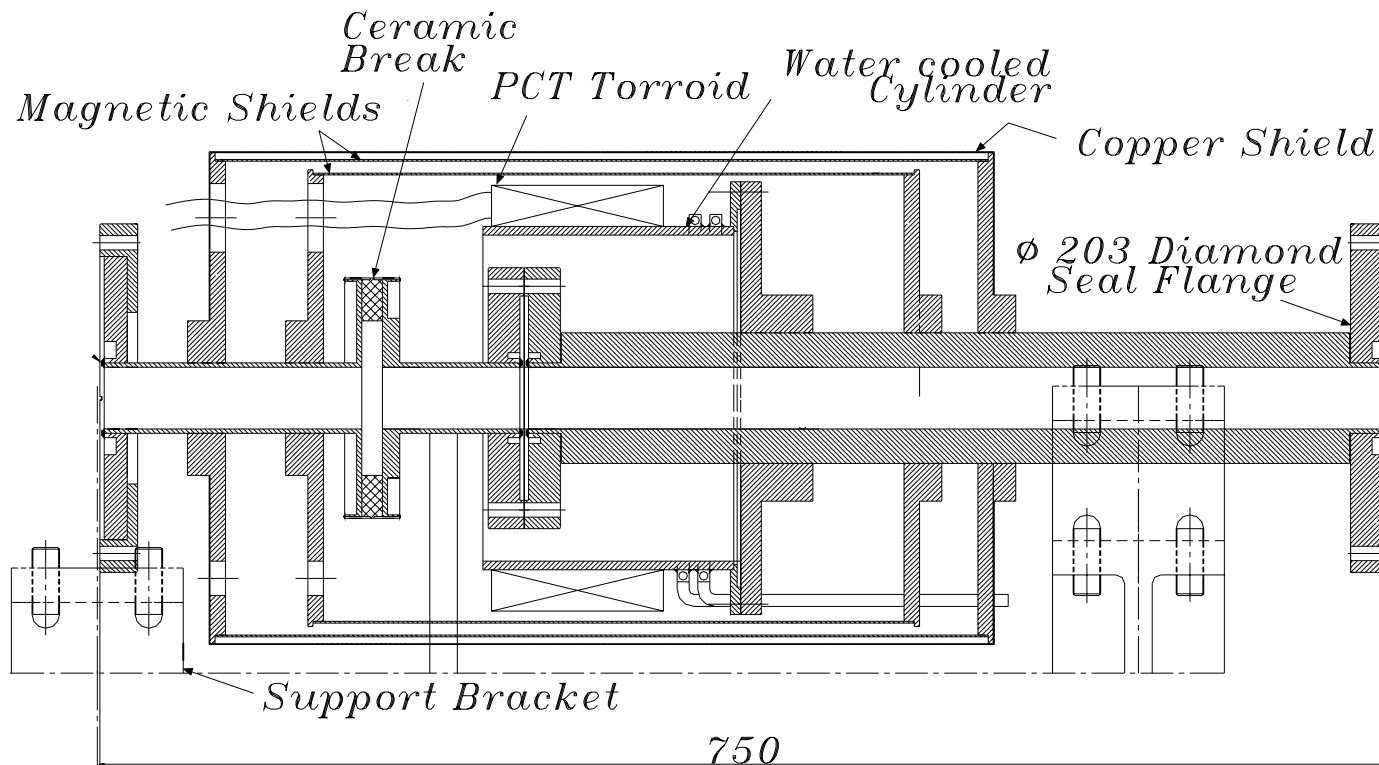

# DCCT Assembly details

Thermal shield

DCCT Core

Mu Metal shield

Ceramic gap with bypass capacitors

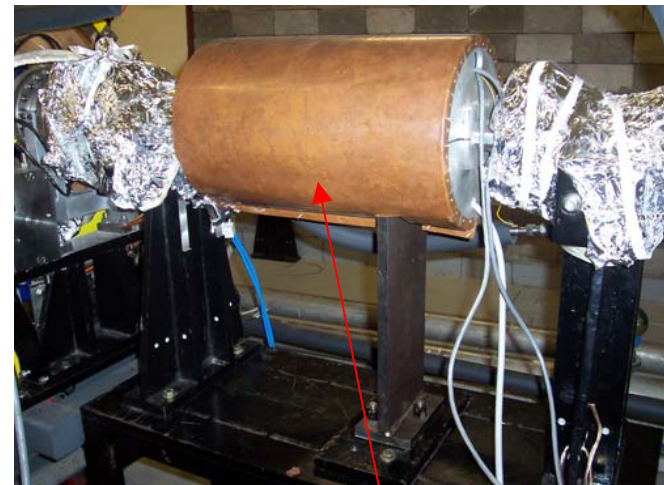
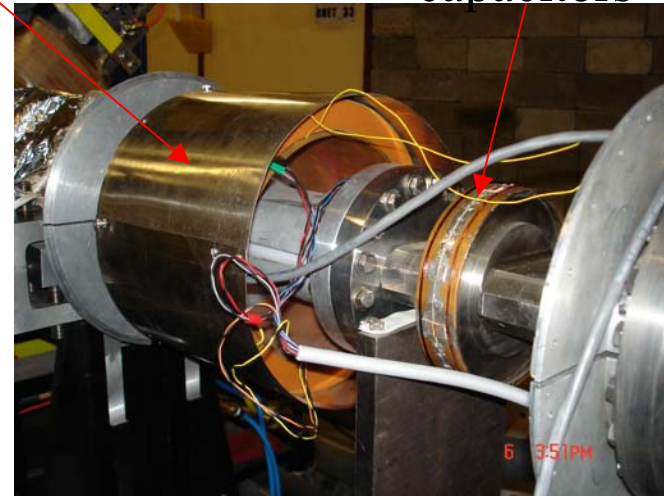
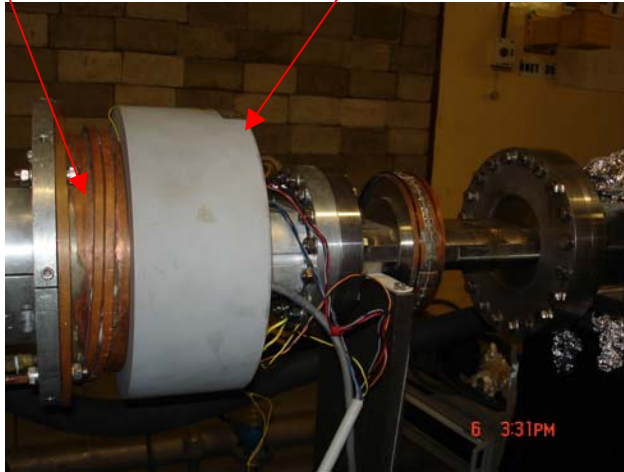

Magnetic shield

Copper shield

# Beam Position Monitor

- Four-button electrode type beam position monitors are used to monitor beam position in Indus-2 ring
- Total 56 nos. in the ring
- 40 individual type and 16 integrated type
- Processing based on narrow band scheme

# Indus-2 Beam Position Monitor Photographs

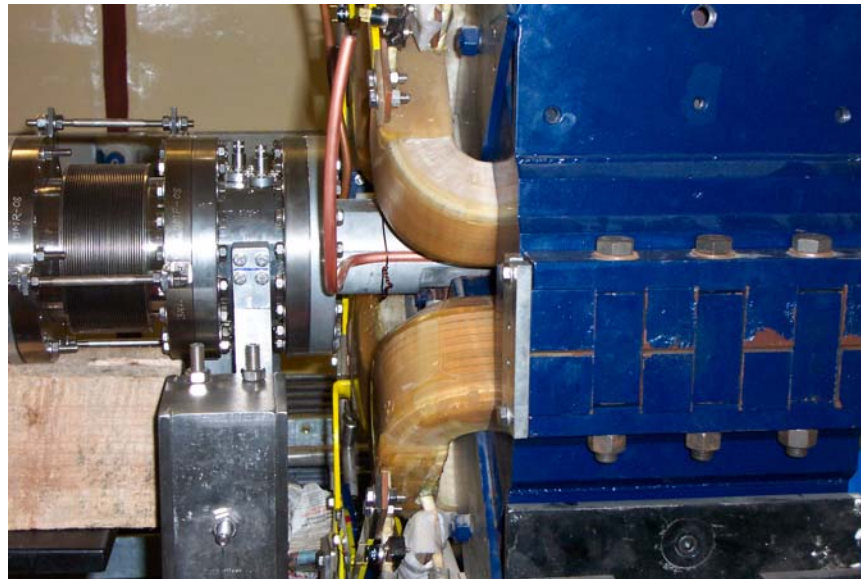
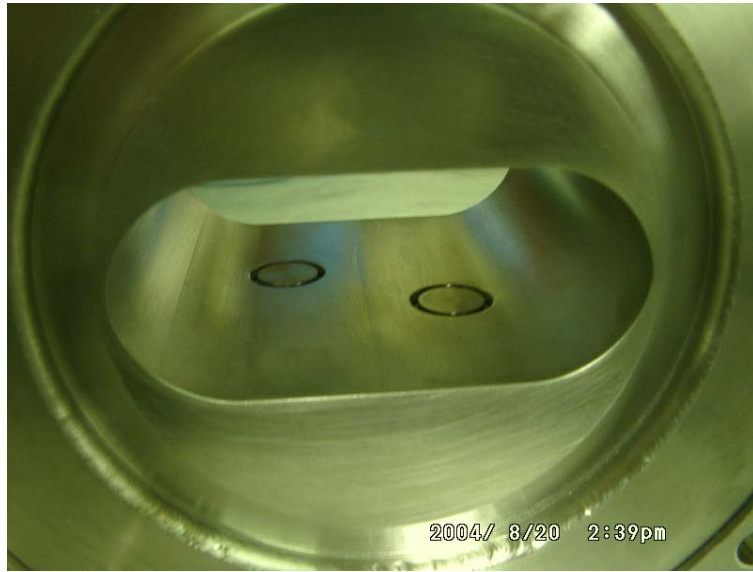

# Typical beam position display in control room

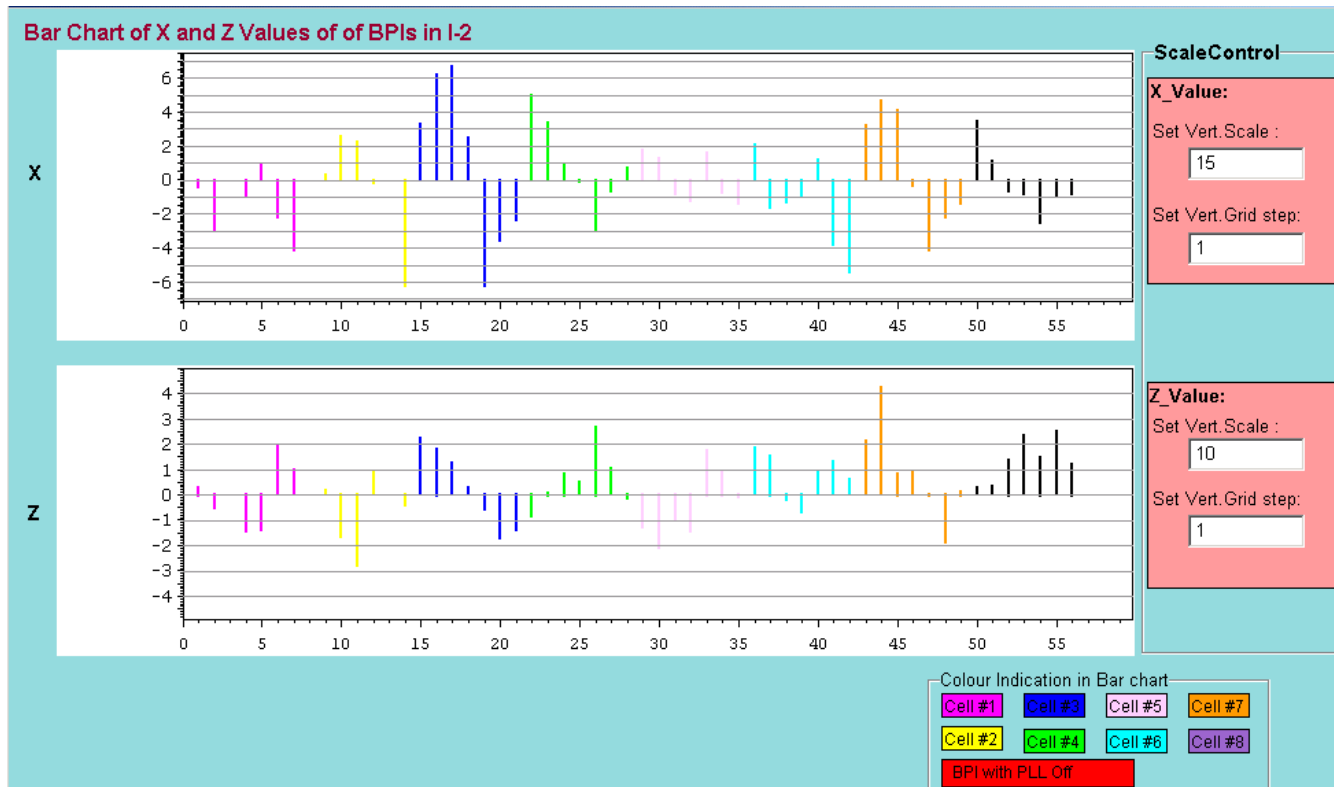



# Betatron Tune

- A particle displaced transversely from its equilibrium orbit executes betatron oscillations about that orbit
- Tune is the number of periods of betatron oscillation in one complete turn
- Typical tune point for Indus-2: 9.2 , 5.2

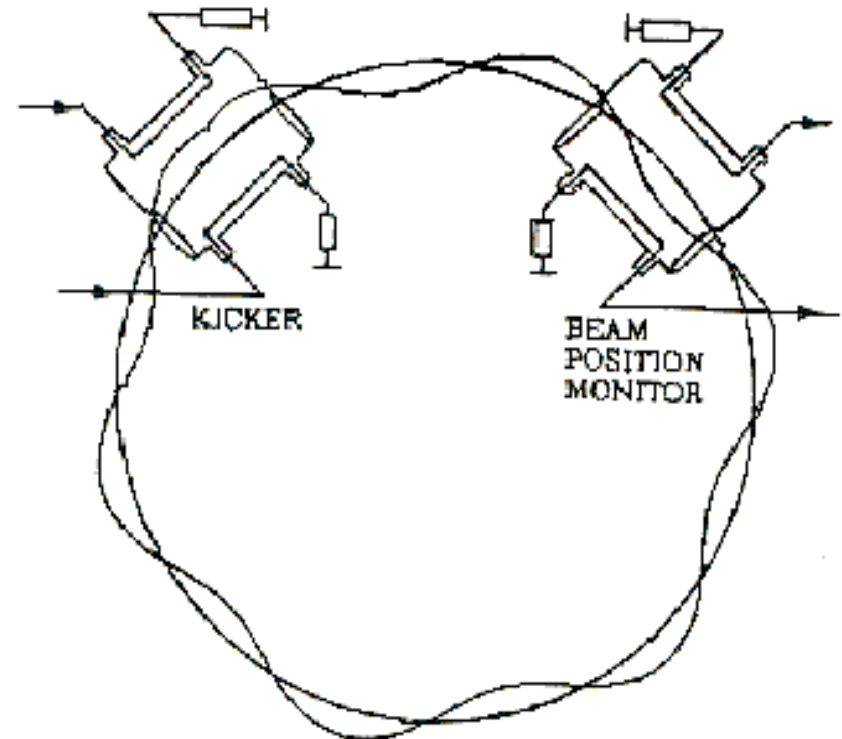

# Tune Measurement

- A transverse excitation is applied to the beam. This causes the beam to execute coherent oscillation
- Beam response is observed using a beam position monitor
- Tune is determined from the frequency spectrum of the beam response

# Tune Measurement ...

- Employs a spectrum analyzer equipped with a tracking generator, which provides the stimulus
- Strip lines are used as transverse kicker and beam position monitor

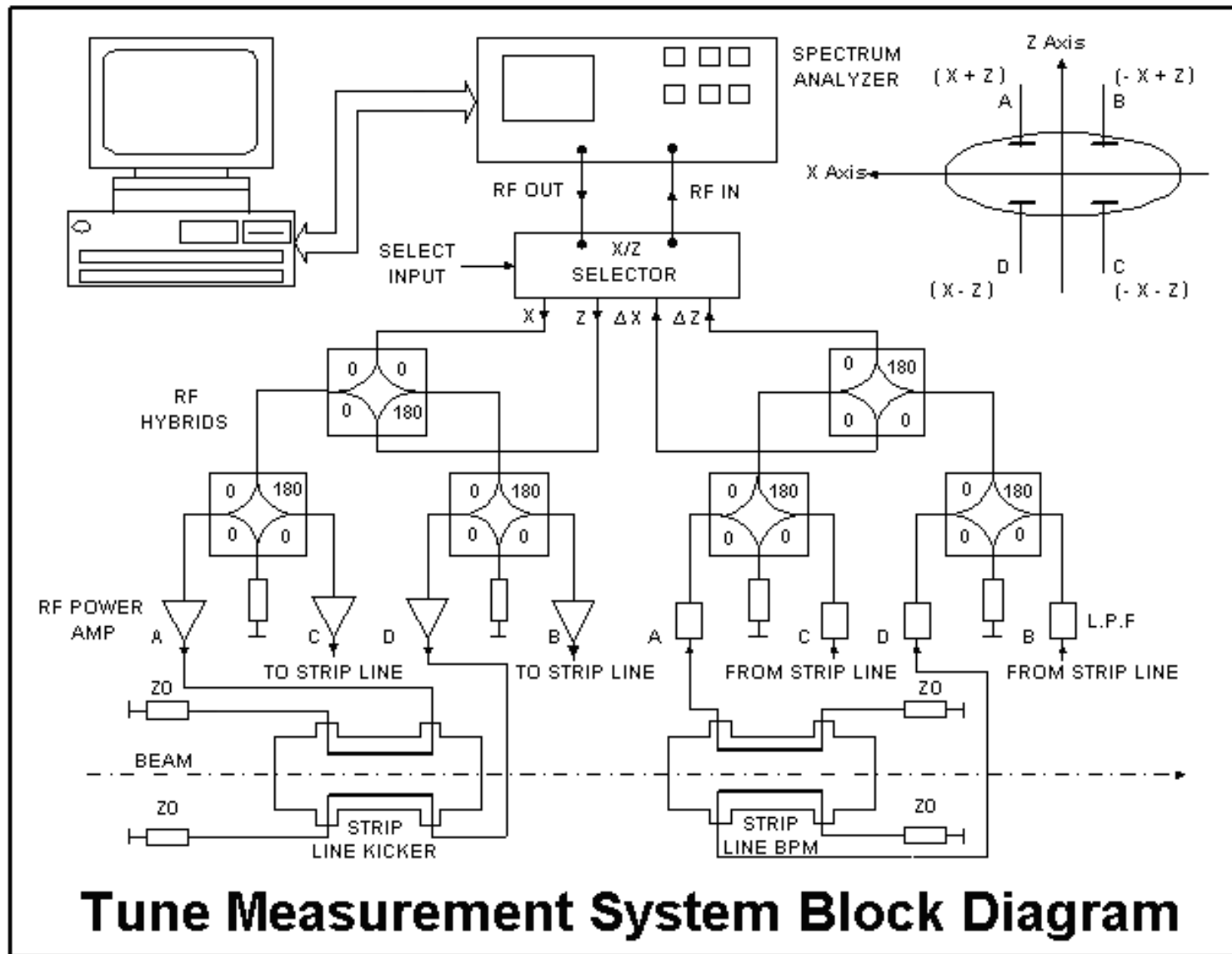

# Transverse beam response spectrum

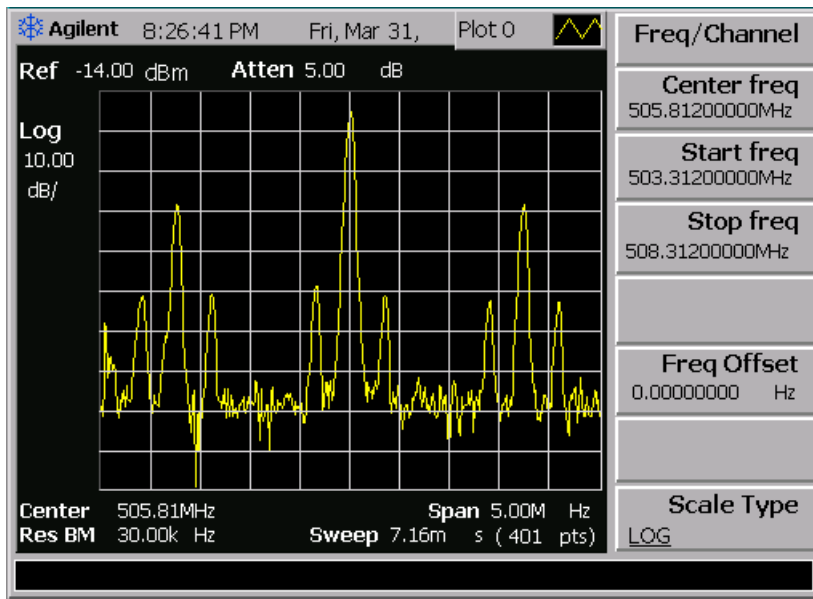

Betatron side bands (horizontal)

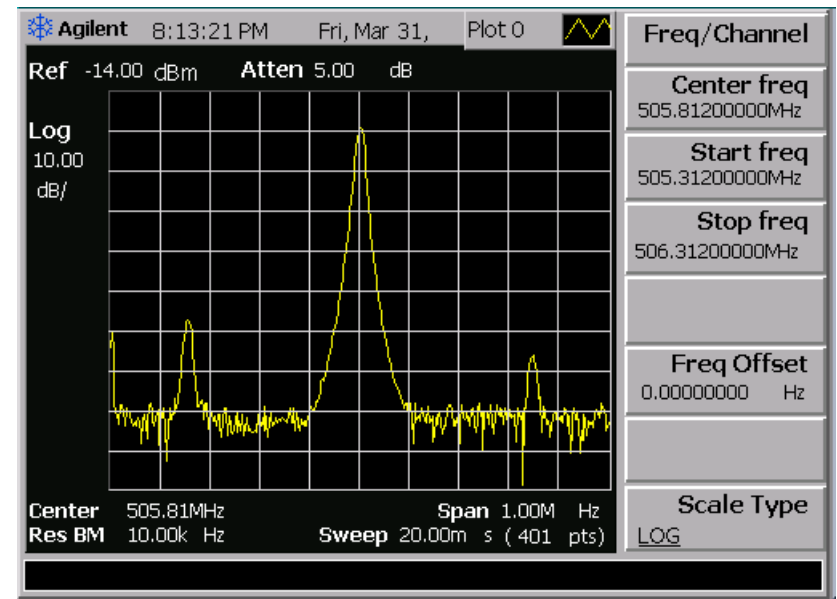

Betatron side bands (horizontal)

Lower side band frequency =  
505.470 MHz,  $\nu_x = 0.196$

# Recent developments

- Beam slit cum profile monitor
- Beam size measurement using fluorescent screen

# Beam slit cum profile monitor

- Multifunction device
  - Slit with adjustable aperture to define the beam (beam scraper)
  - Quantitative beam profile measurement (destructive)
  - Can act like a conventional fluorescent screen for observing (visual) beam profile
  - Allows central portion of the beam to pass through while one can view the beam edges falling on the jaws (blades)
- One device has been installed at the starting of Transfer Line-1

# Photograph of beam slit (view rotated by 45°)





# Features of beam slit

- Beam current captured by individual blade can be measured
- Fluorescent screen (Cr doped Alumina) is mounted on each blade (jaw)
- View port to see the blades through a CCD camera
- Remote operation

## Result of experiment done on 26/11/07 using TL-1 beam slit

The right hand side blade of the slit was moved towards the beam in steps of 0.5 mm in the range of  $-6$  mm to  $+2$  mm keeping other three blades in OUT condition. At every step, blade current (voltage across  $50 \Omega$ ), FCT1 and FCT2 signals were recorded. Following figure shows the graph.

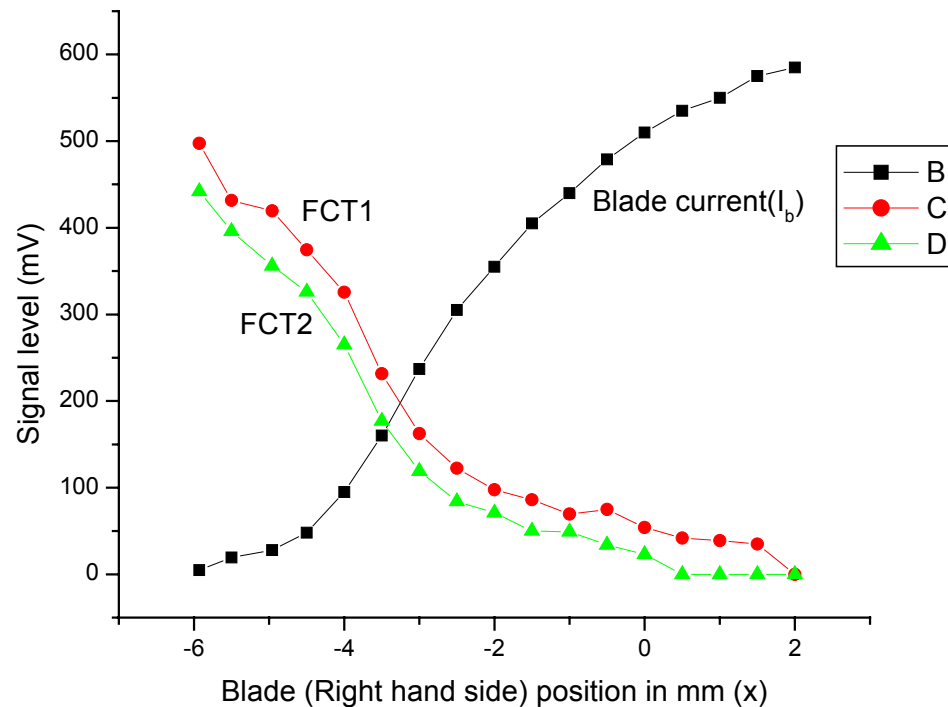

Following graph is obtained by differentiating blade signal with respect to  $x$ , which gives the horizontal beam profile. (FWHM  $\sim 3.6$  mm,  $x$  pos  $\sim -3.1$  mm)

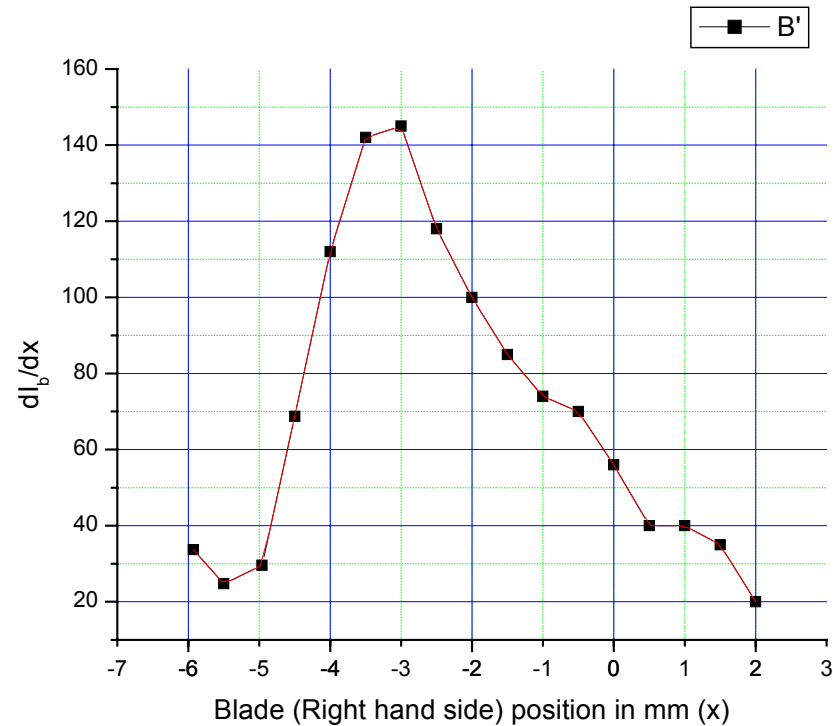

(Experiment was done by: T.A.Puntambekar, P. Shrivastav, J.Dwivedi, A.C.Holikatti)

Experiment done on 07/12/07 (19:00 to 19:20 Hrs) with vertical blade of TL-1 slit monitor

The vertical (down) blade was scanned from +21 mm to -2 mm in steps of 1 mm and the time integrated blade signal (average of ~10 sweeps) was recorded. The obtained data is plotted below.

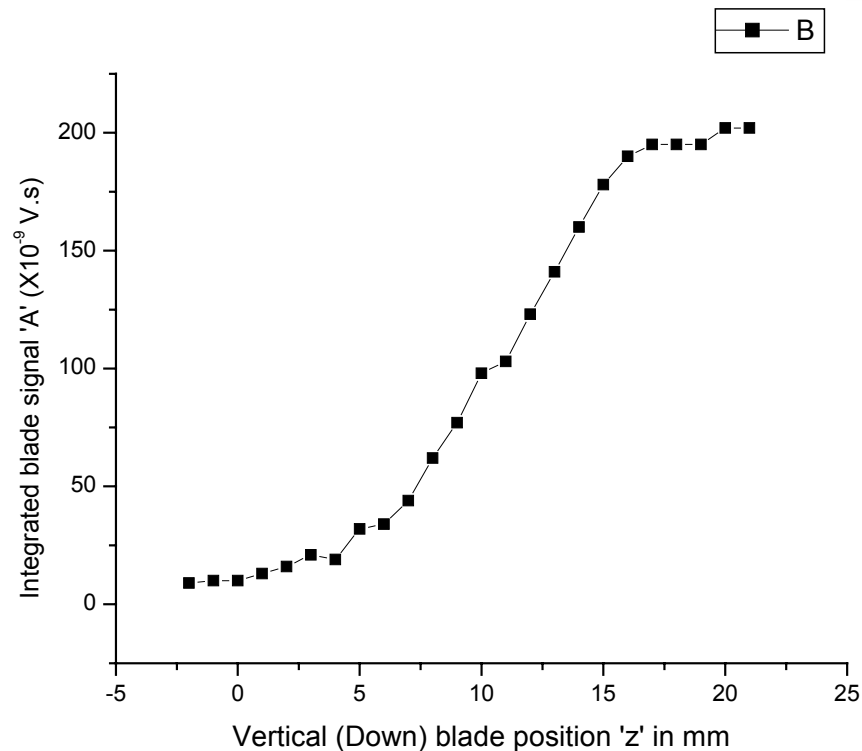

- Vertical beam profile obtained by differentiating w.r.t. blade position and smoothing of above graph is given below

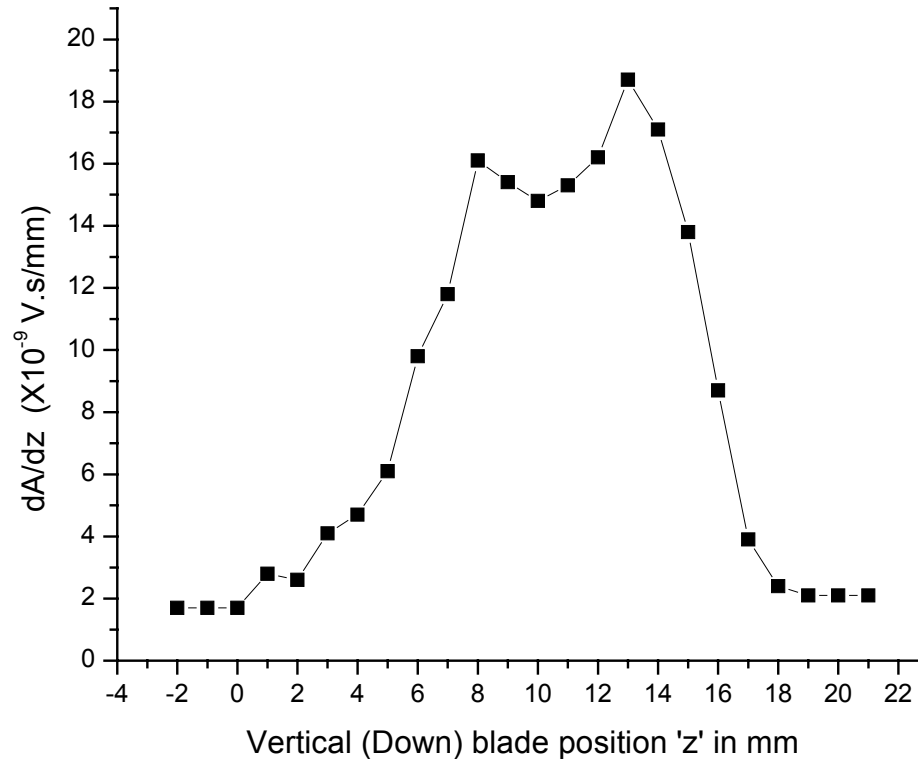

- Beam slit cum profile monitor has proved to be a very useful diagnostic tool in TL-1
- More numbers of such devices will be installed at other locations in Indus complex
- This will help in optimizing the beam transport and machine performance

# Beam size measurement using fluorescent screen

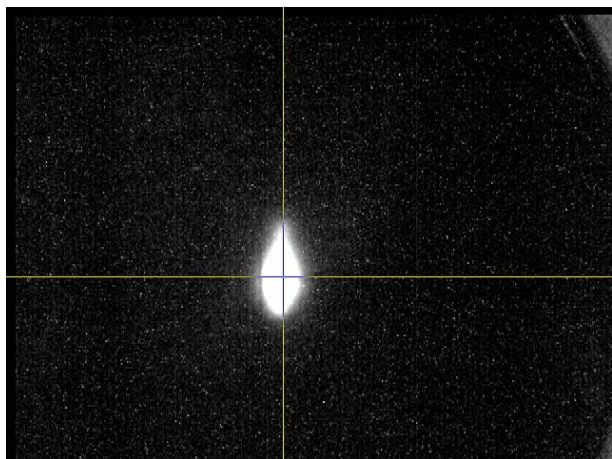

Hor. Profile  
 $\pm\sigma = 3.48$  mm

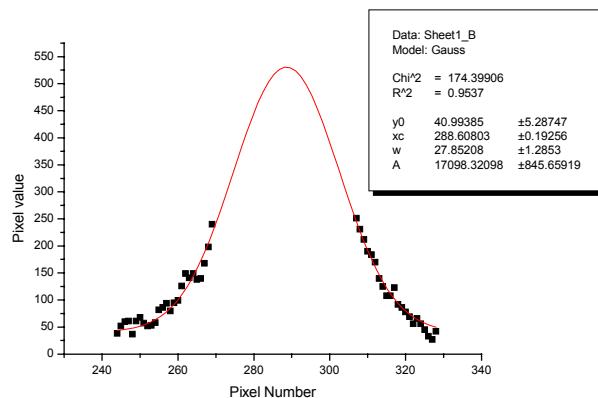

Beam spot observed at  
Transfer Line-1 BPM #2

Ver. Profile  
 $\pm\sigma = 7.34$  mm

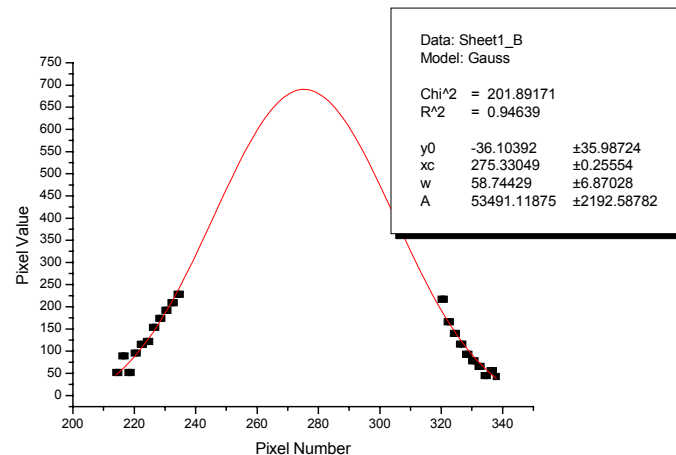

Thank You